

## Zadaci za 2. program

Svakom studentu, nakon što obrani 1. program nastavnik/ica će pridružiti jednu grupu zadataka. Svaka grupa zadataka sastoji se od 3 predloška koji određuju oblik tijela/objekta, pri čemu je jedno od njih vez dviju drvenih greda. Tijela se sastoje od uglatih i oblih dijelova, čije su duljine na predlošcima izražene u milimetrima.

U zadatku je potrebno napraviti sljedeće:

- Za 1. zadani objekt konstruirati izometrijsku sliku u olovci (izometrija je kosa aksonometrija kod koje su jedinice na sve tri osi jednake - uzmite prikrate  $m = n = p = 1$ ).
  - Ishodište koordinatnog sustava postavite u položaj koji procjenjujete najpovoljnijim za konstrukciju.
  - Zbog preglednosti aksonometrijskog prikaza objekta možete udvostručiti mjere na predlošku.
  - Taj zadatak izrađujete kod kuće i donosite nastavnicu na početku konstrukcijskih vježbi.
- Modelirati sva tri zadana objekta u programu *Rhinoceros*.
  - Samostalno proradite osnove programa pomoću nastavnog materijala pod naslovom *Uvodno o programu Rhinoceros*.
  - Budući da u ovom programu modelirate tijela, pri rješavanju zadataka koristite uglavnom one naredbe koje se nalaze u izborniku *Solid*.
- Nastavnik/ica može vam zadati još 1 ili 2 dodatna zadatka.

# 1. grupa zadataka

1.

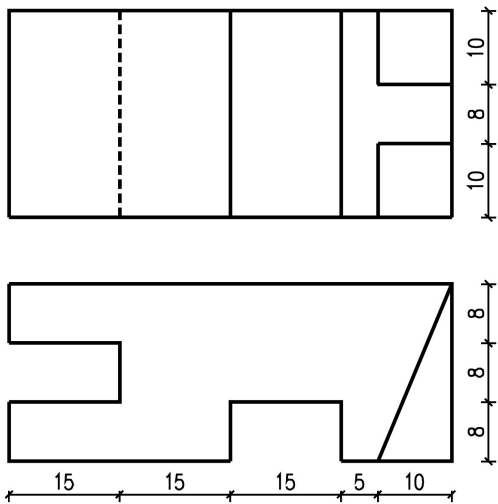

2.

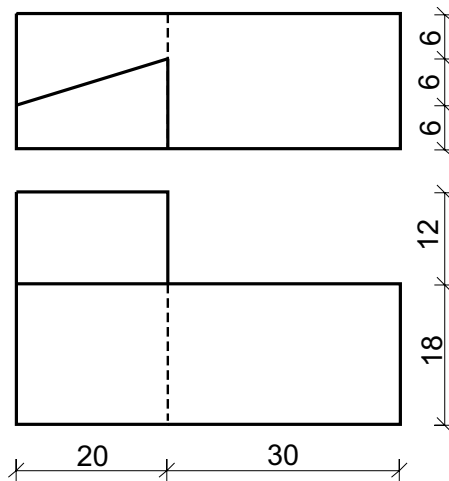

3.

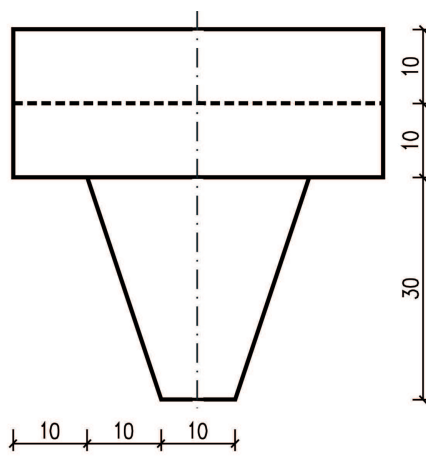
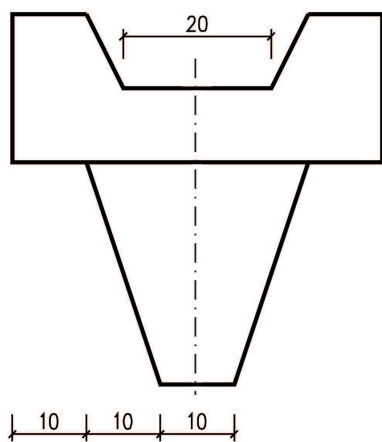

## 2. grupa zadataka

1.

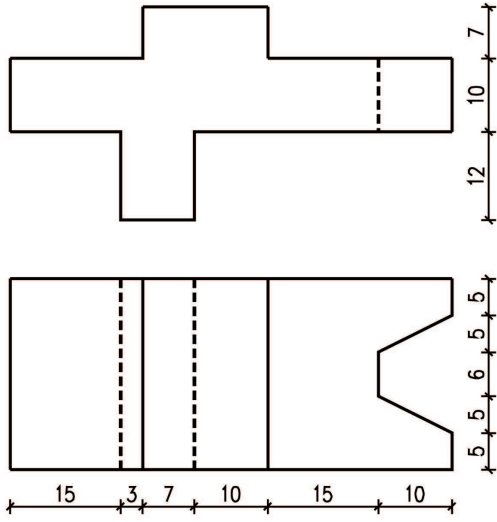

2.

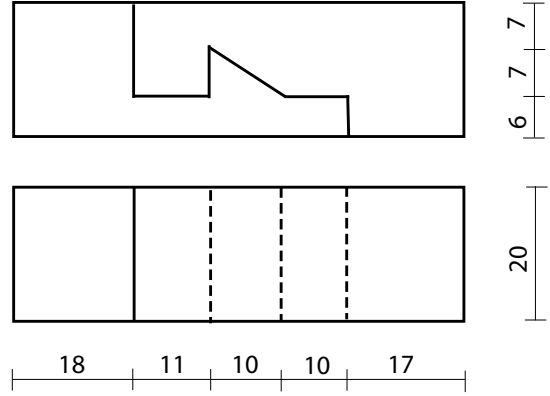

3.

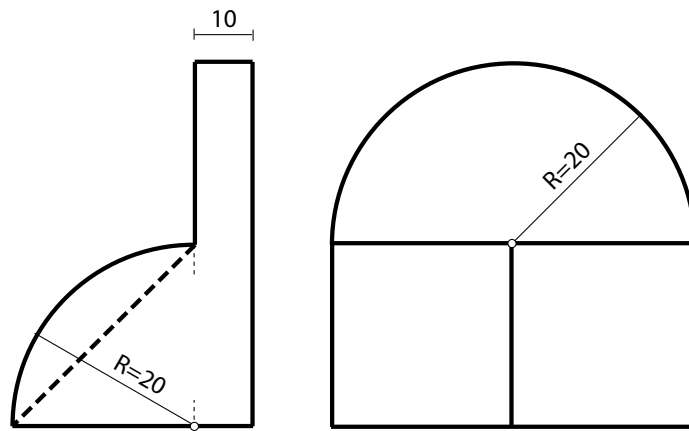

### 3. grupa zadatka

1.

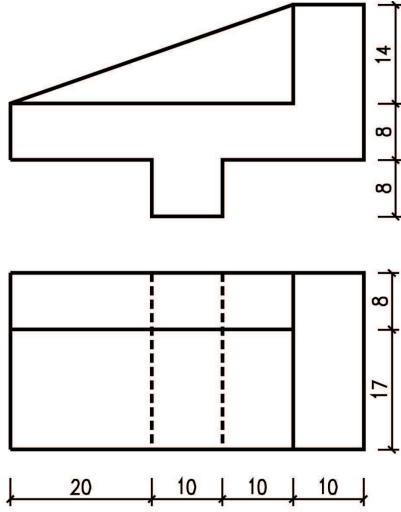

2.

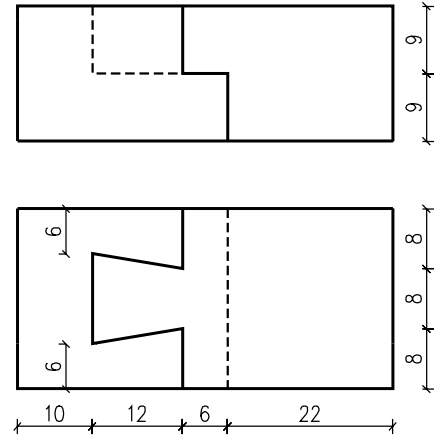

3.

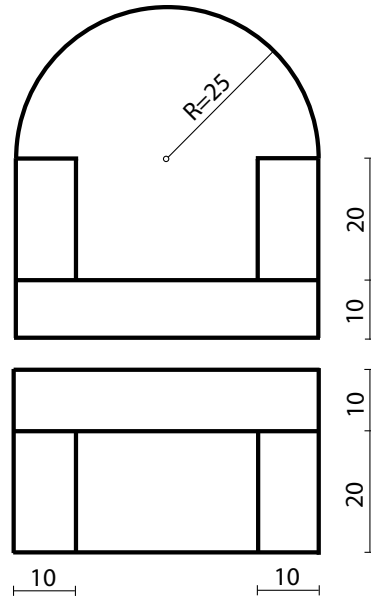

4. grupa zadatka

1.

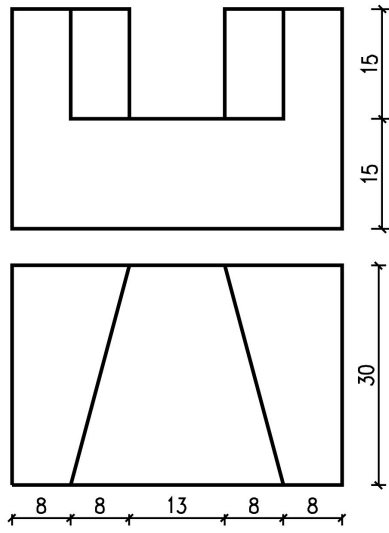

2.

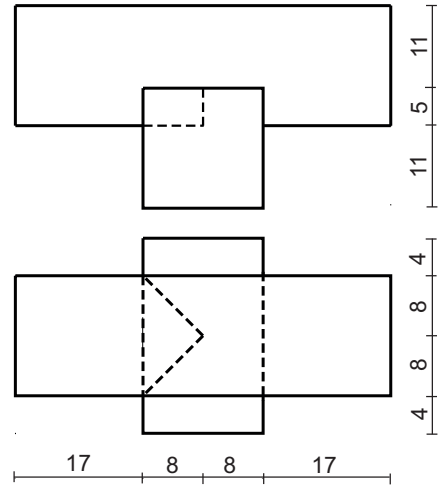

3.

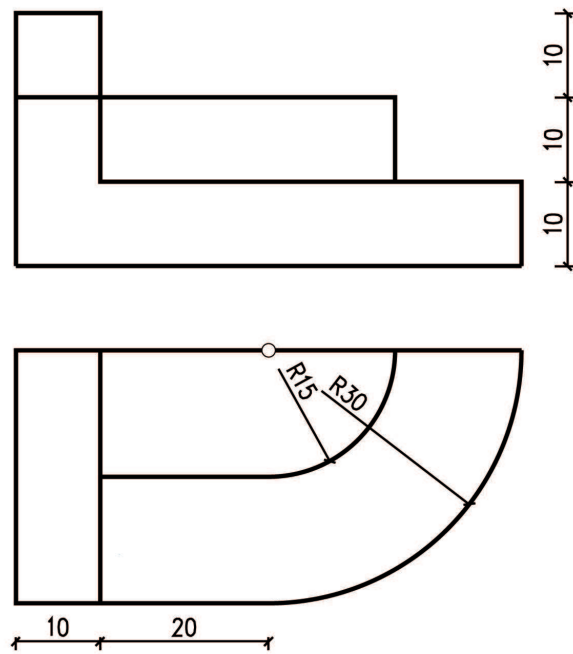

### 5. grupa zadatka

1.

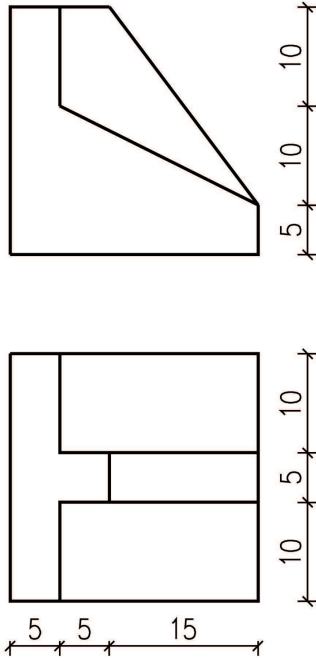

2.

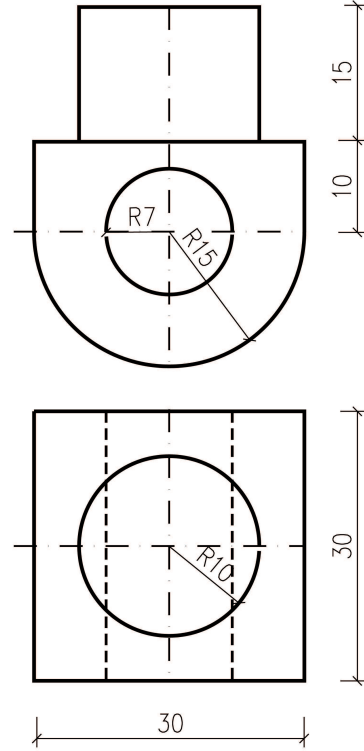

3.

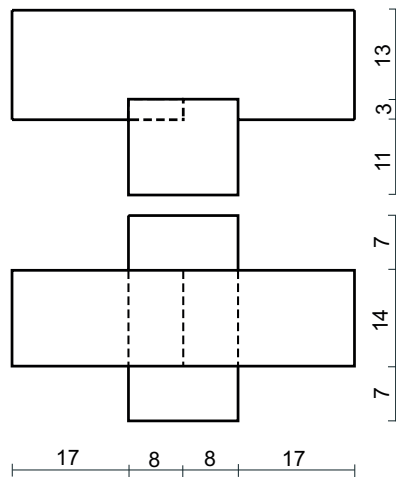

6. grupa zadatka

1.

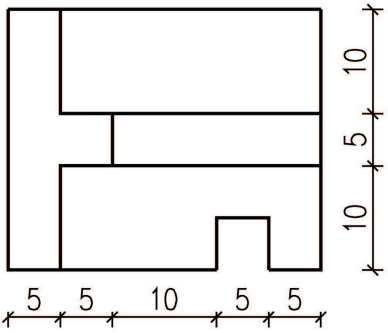
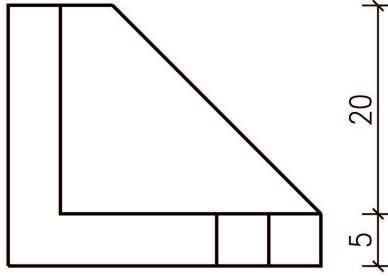

2.

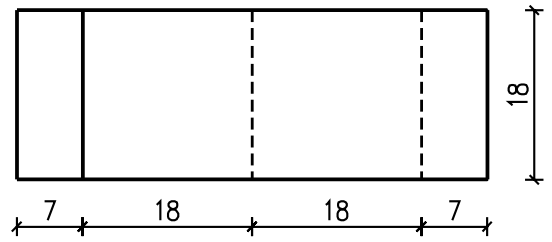
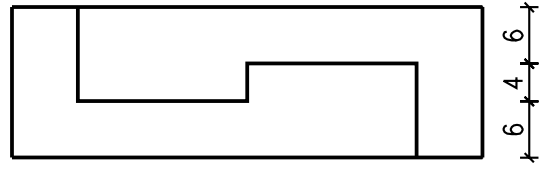

3.

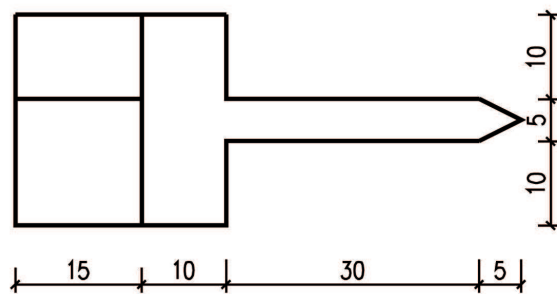
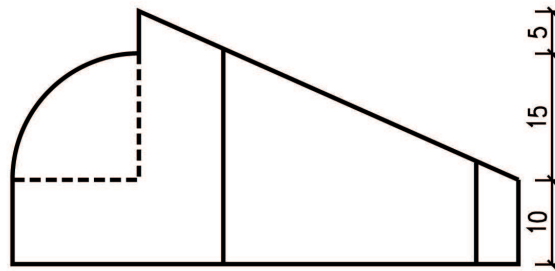

7. grupa zadatka

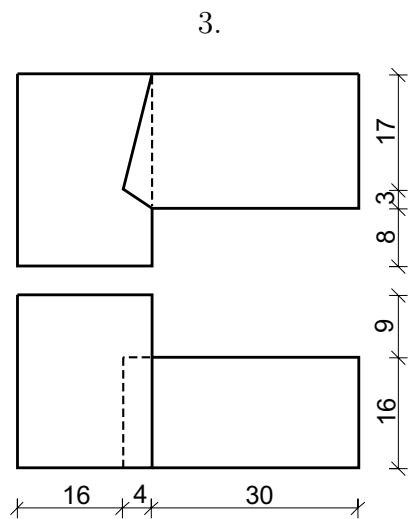
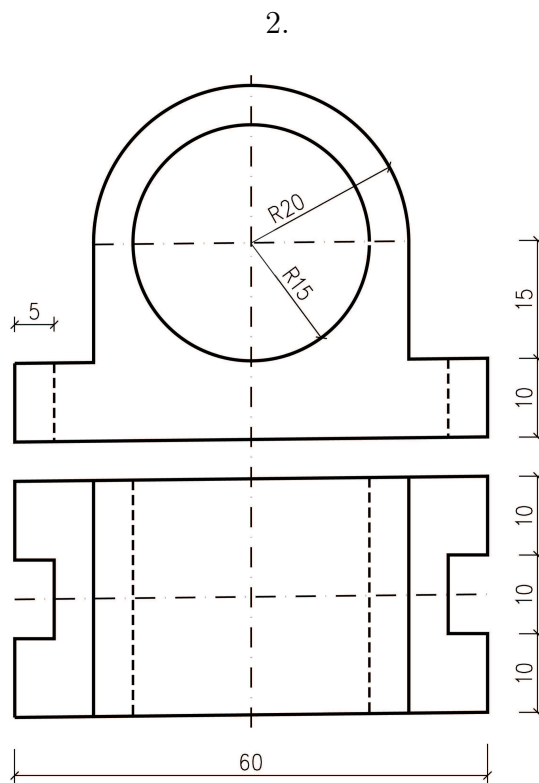
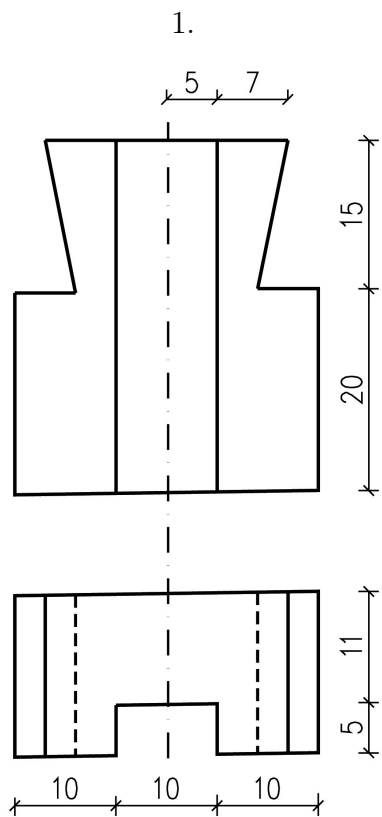



### 8. grupa zadatka

1.

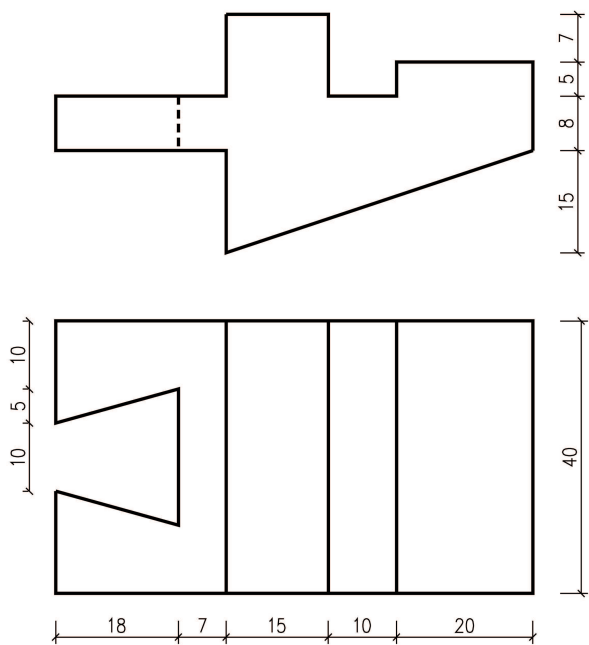

2.

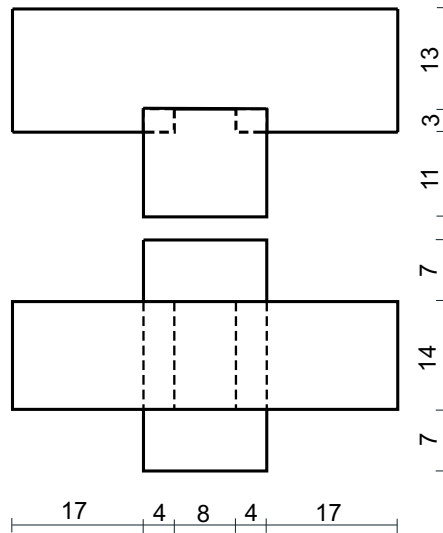

3.

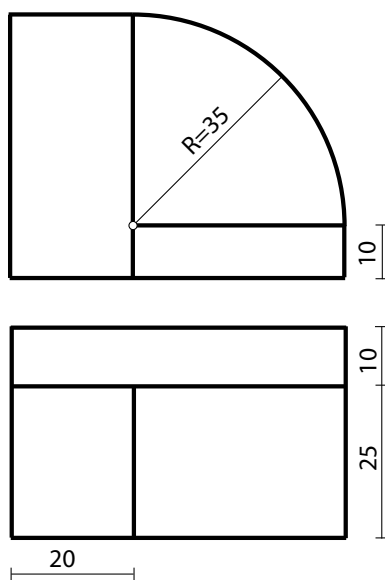

9. grupa zadatka

1.

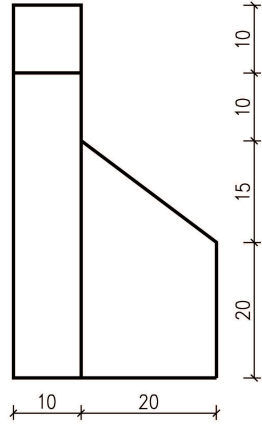
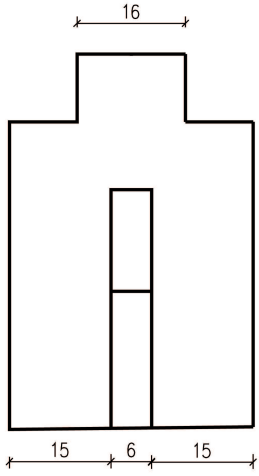

2.

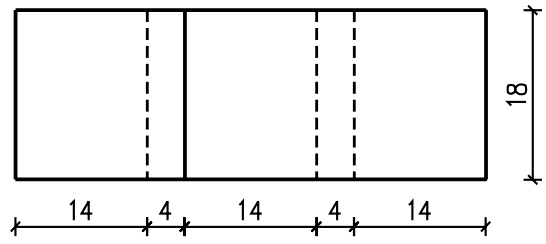
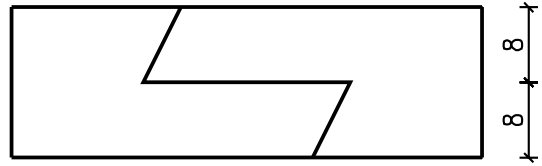

3.

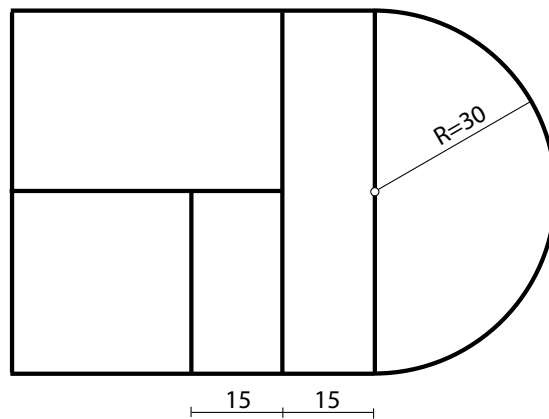
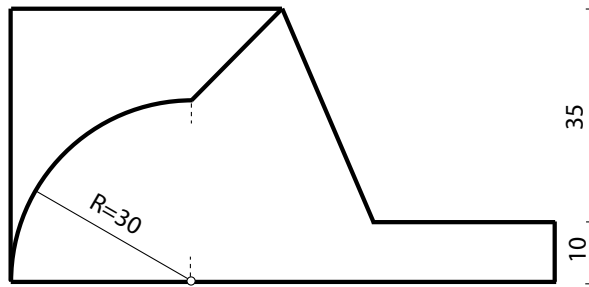

# 10. grupa zadatka

1.

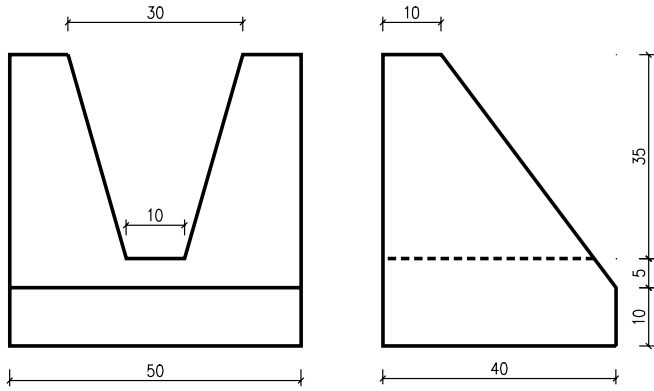

2.

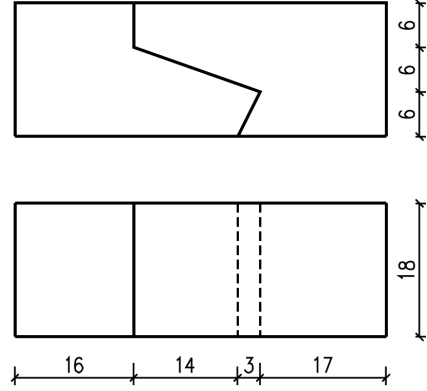

3.

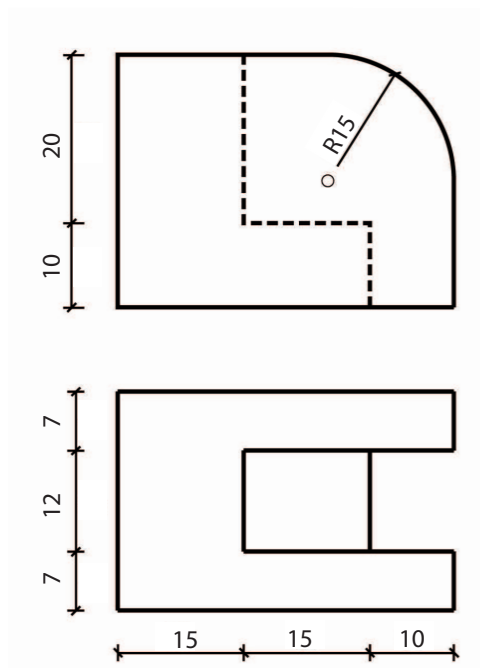

11. grupa zadatka

1.

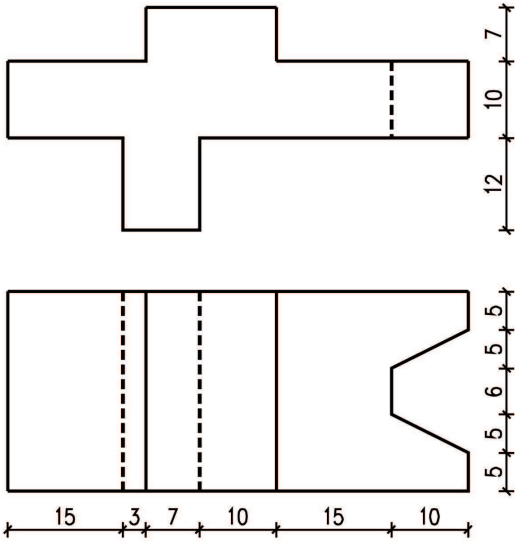

2.

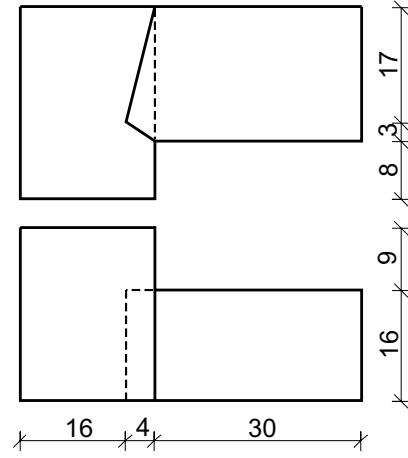

3.

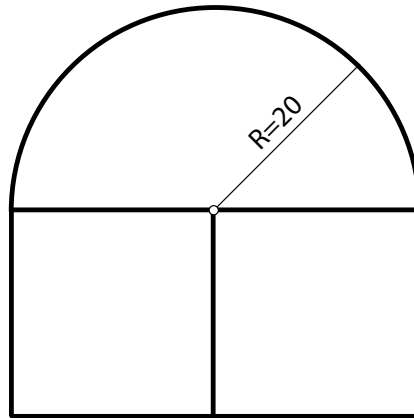
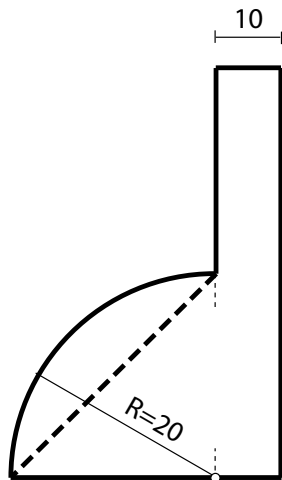

## 12. grupa zadatka

1.

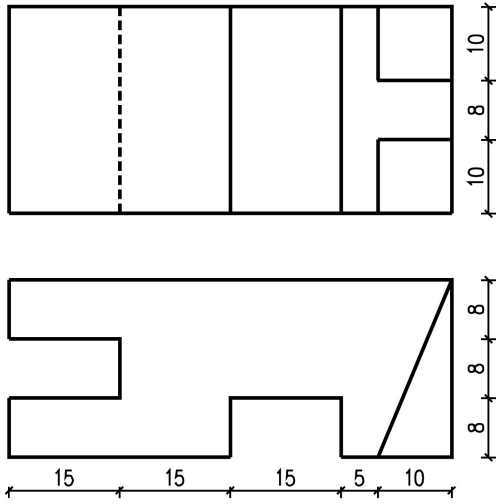

2.

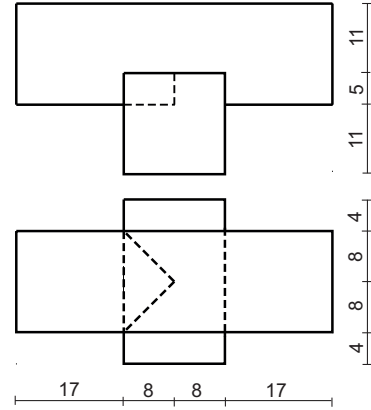

3.

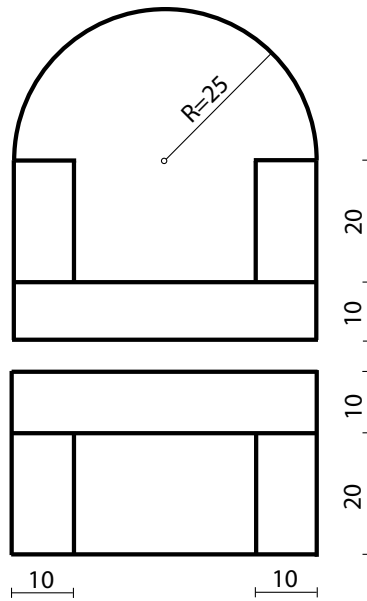

13. grupa zadatka

1.

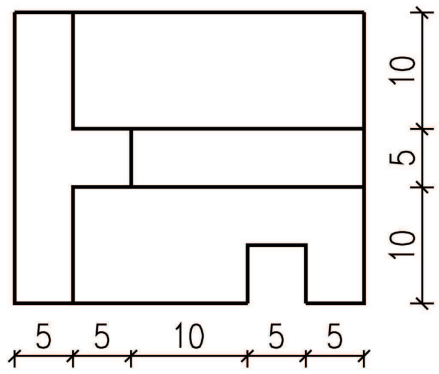
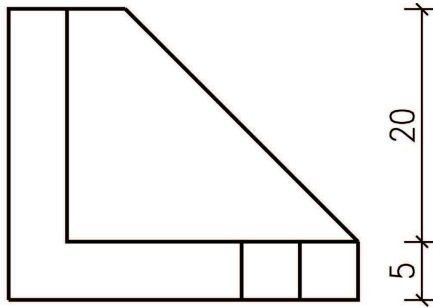

2.

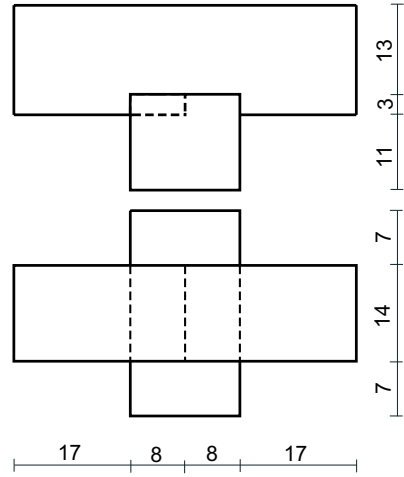

3.

