

Zadaci za 2. program

2. program izrađuje se u računalnoj učionici u programu *Rhinoceros* tijekom konstrukcijskih vježbi.

Svakom studentu, nakon što obrani 1. program nastavnica će pridružiti jednu grupu zadataka. Svaka grupa zadataka sastoji se od 3 predloška koji određuju oblik tijela/objekta, pri čemu je jedno od njih vez dviju drvenih greda. Tijela se sastoje od uglatih i oblih dijelova, čije su duljine na predlošcima izražene u milimetrima.

U zadatku je potrebno napraviti sljedeće:

- Za 1. zadani objekt konstruirati izometrijsku sliku u olovci (izometrija je kosa aksonometrija kod koje su jedinice na sve tri osi jednake - uzmite prikrate $m = n = p = 1$).
 - Ishodište koordinatnog sustava postavite u položaj koji procjenjujete najpovoljnijim za konstrukciju.
 - Zbog preglednosti aksonometrijskog prikaza objekta možete udvostručiti mjere na predlošku.
 - Taj zadatak izrađujete kod kuće i donosite nastavnicu na početku konstrukcijskih vježbi.
- Na konstrukcijskim vježbama trebate modelirati sva tri zadana objekta u programu *Rhinoceros*.
 - Prije dolaska na konstrukcijske vježbe, samostalno proradite osnove programa pomoću nastavnog materijala pod naslovom *Uvodno o programu Rhinoceros*.
 - Budući da u ovom programu modelirate tijela, pri rješavanju zadataka koristite uglavnom one naredbe koje se nalaze u izborniku *Solid*.
- Ukoliko tijekom vježbi, unutar prvih 60 minuta, riješite sve zadatke iz svog programa vaša ocjena može biti najviše dobar (3).
- Za višu ocjenu trebate na istim vježbama izraditi još 1 ili 2 dodatna zadatka koje će vam nastavnica zadati neposredno na vježbama.

1. grupa zadataka

1.

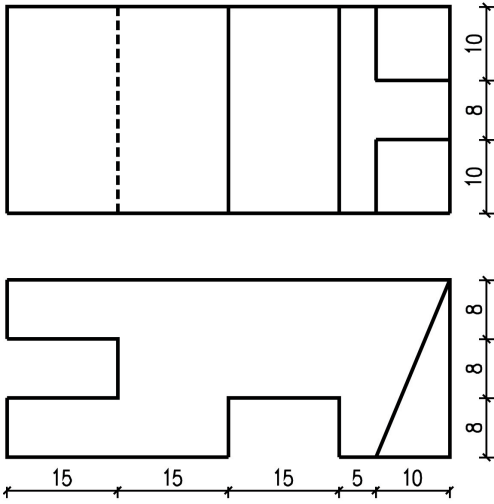

2.

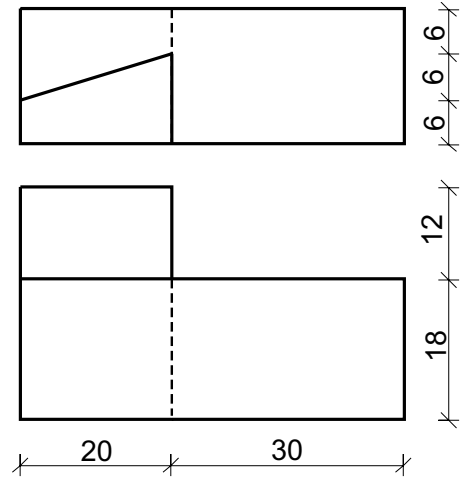

3.

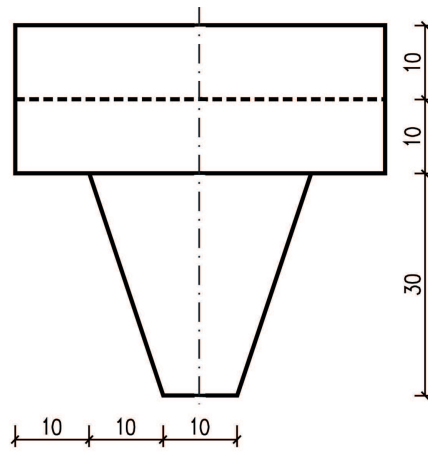
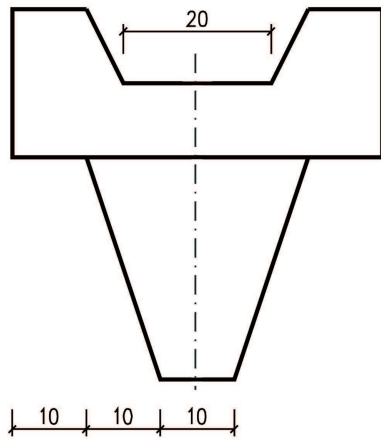

2. grupa zadatka

1.

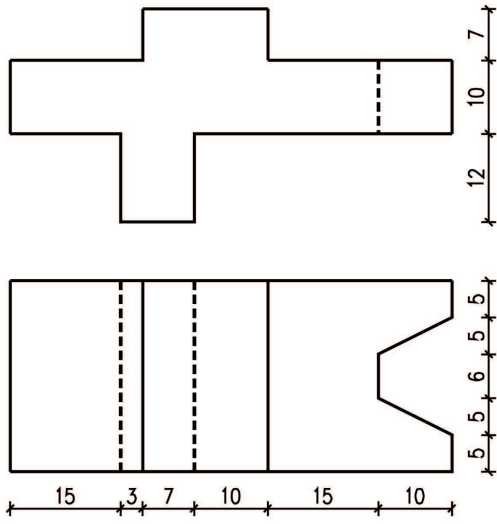

2.

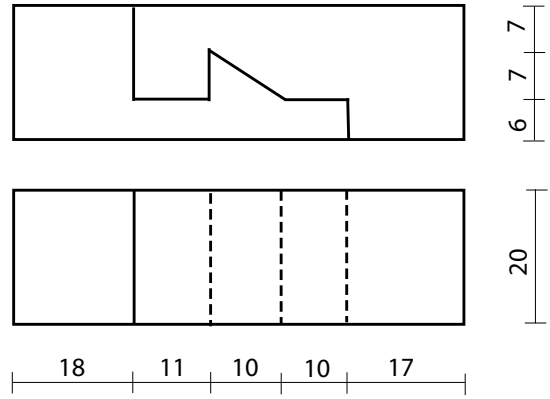

3.

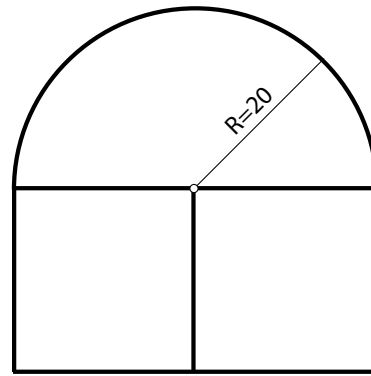
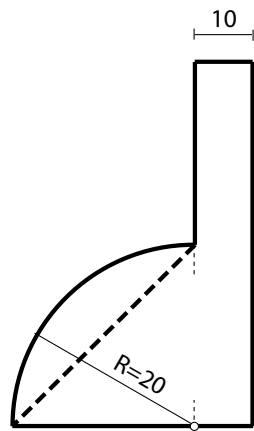

3. grupa zadatka

1.

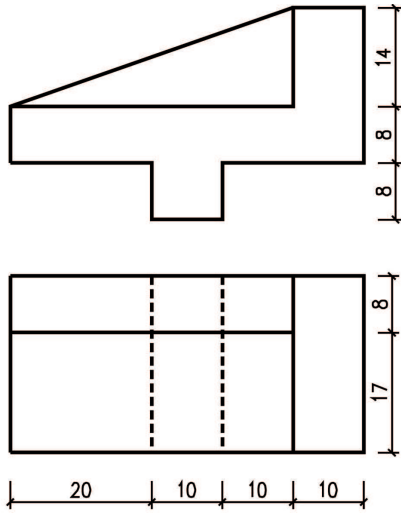

2.

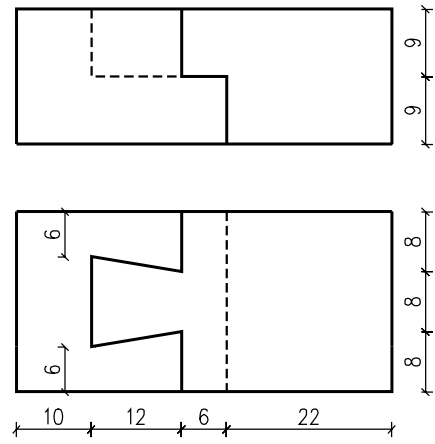

3.

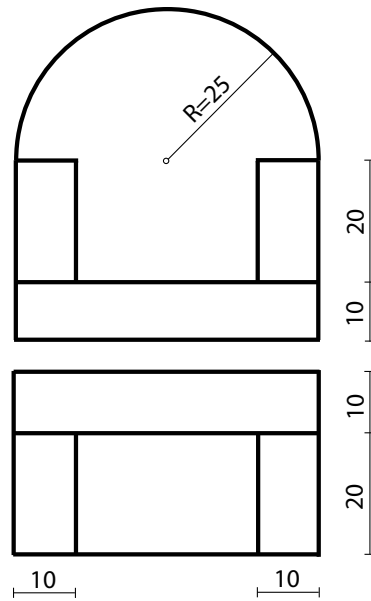

4. grupa zadatka

1.

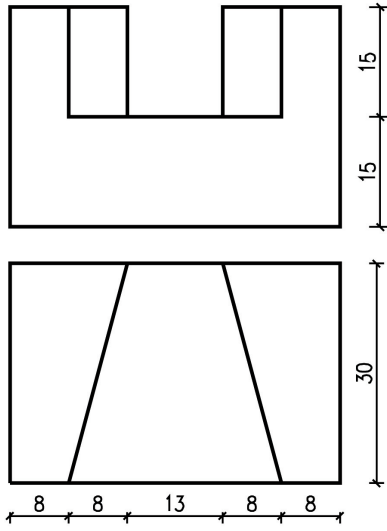

2.

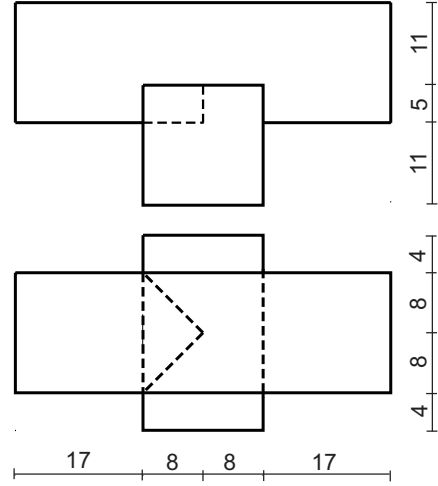

3.

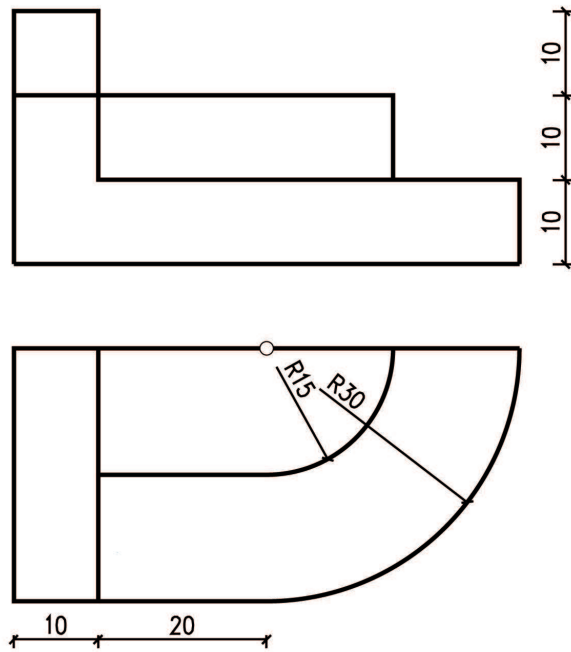

5. grupa zadatka

1.

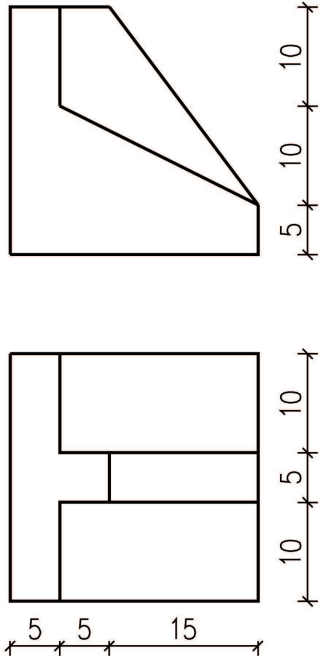

2.

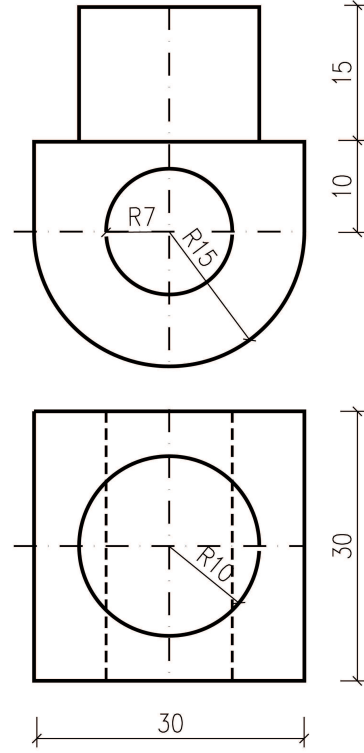

3.

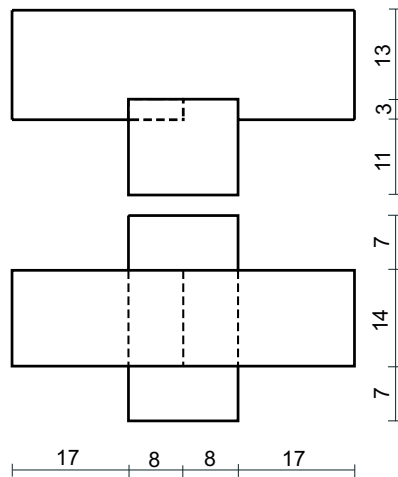

6. grupa zadatka

1.

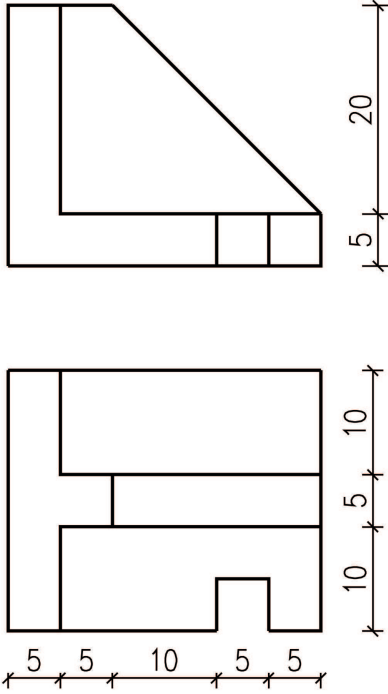

2.

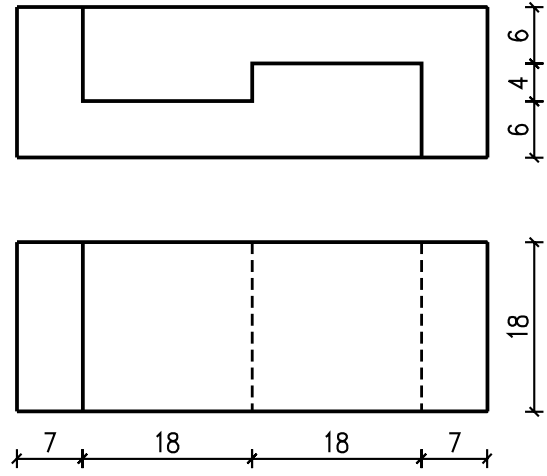

3.

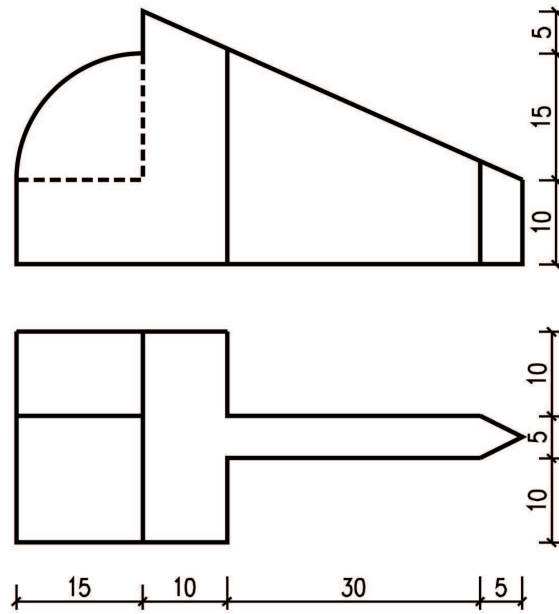

7. grupa zadatka

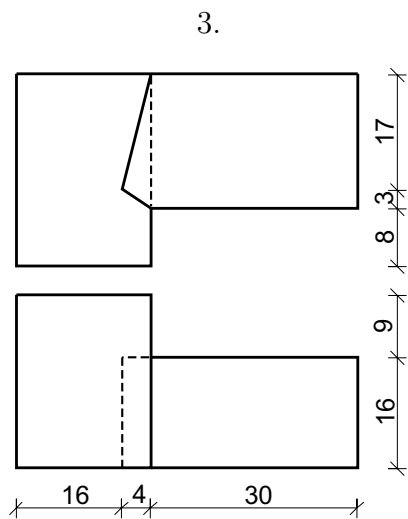
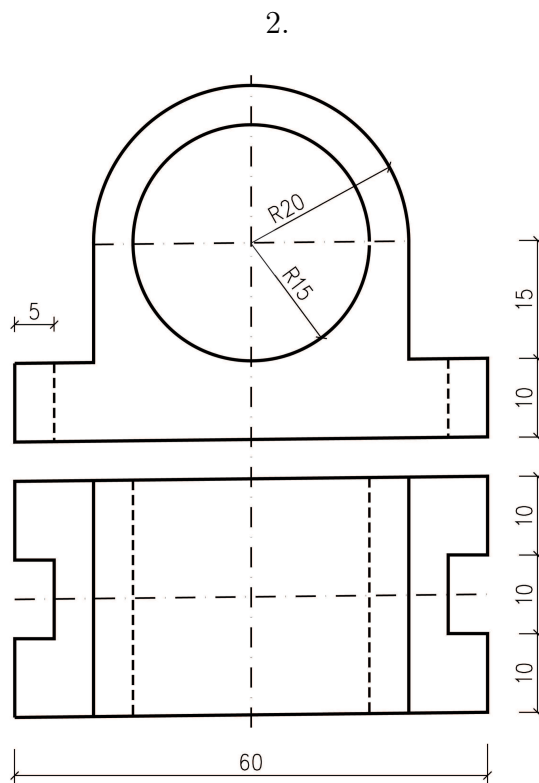
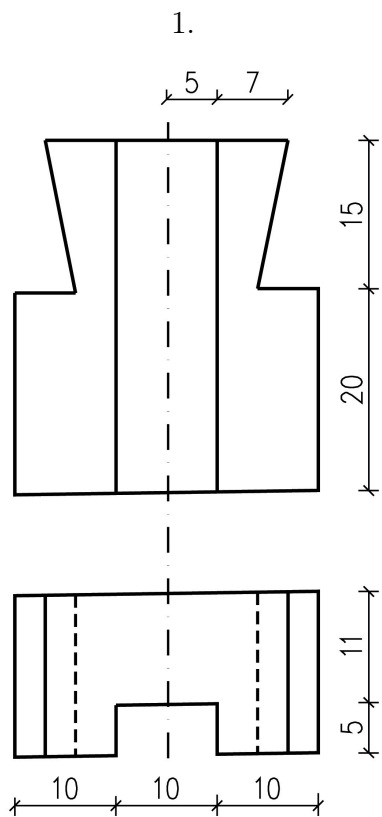

8. grupa zadatka

1.

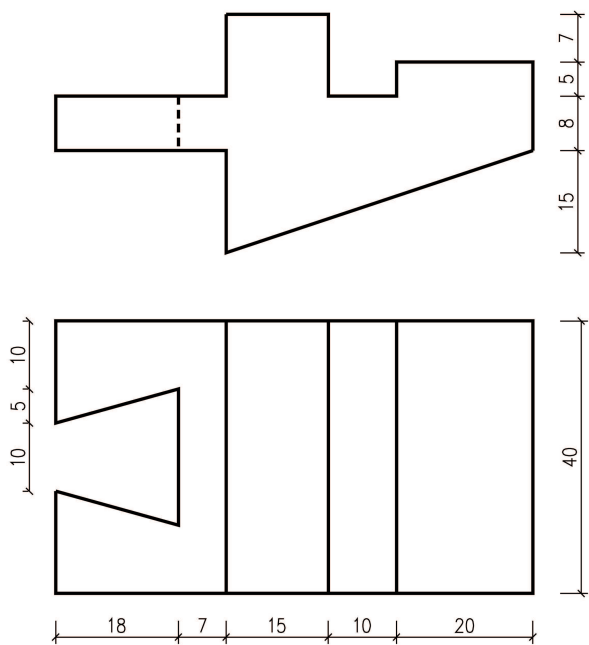

2.

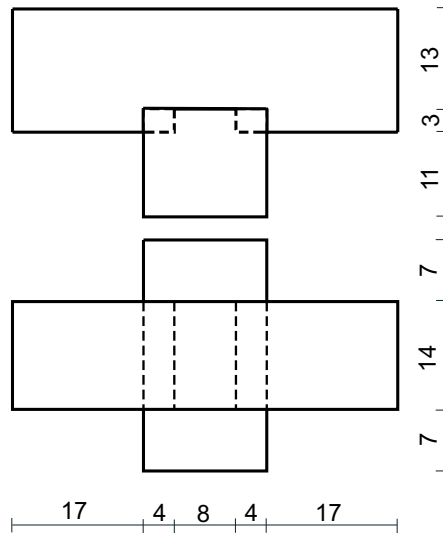

3.

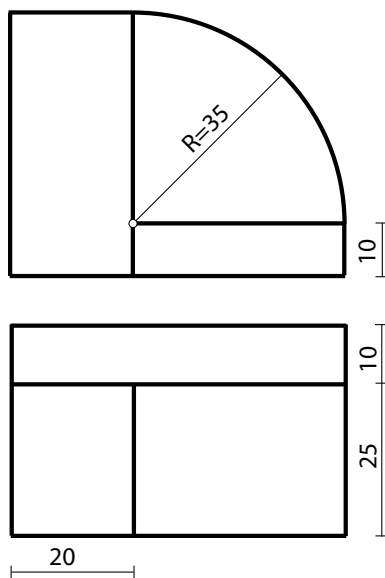

9. grupa zadatka

1.

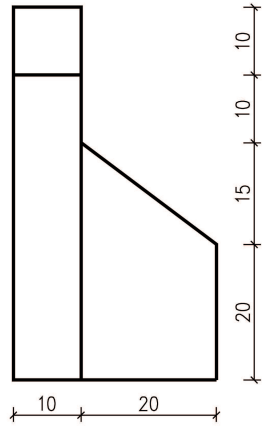
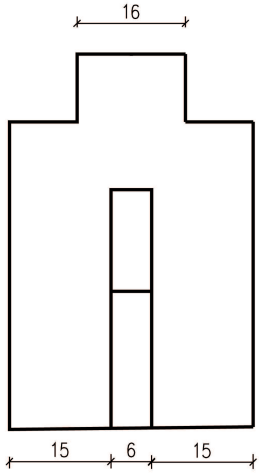

2.

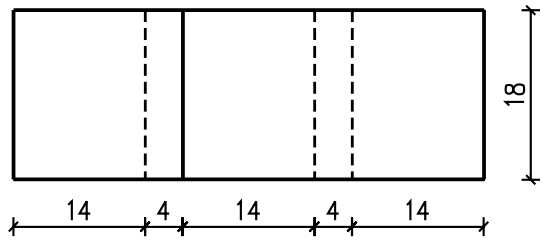
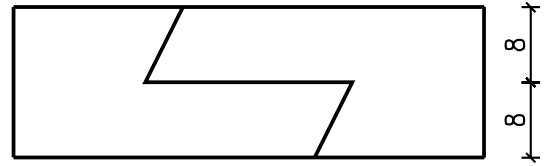

3.

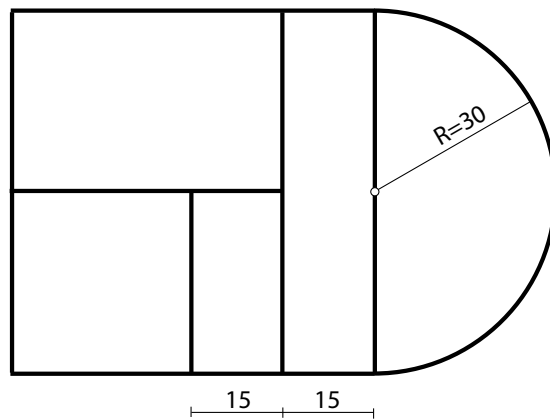
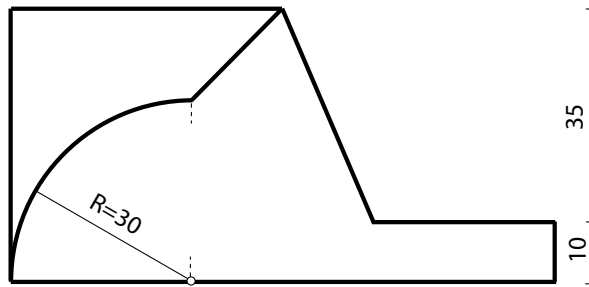

10. grupa zadatka

1.

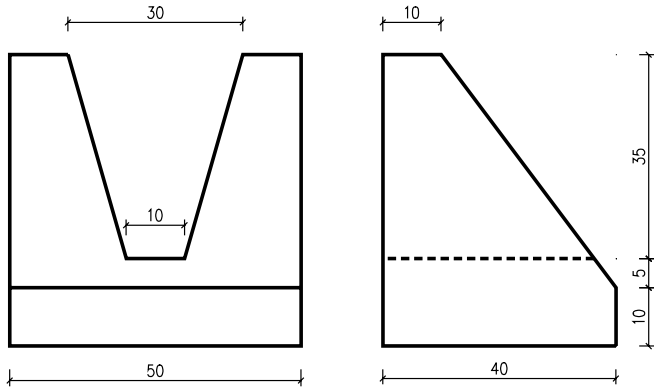

2.

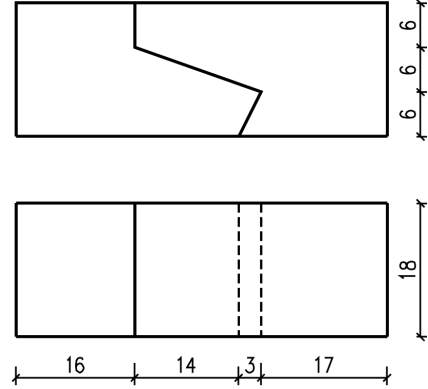

3.

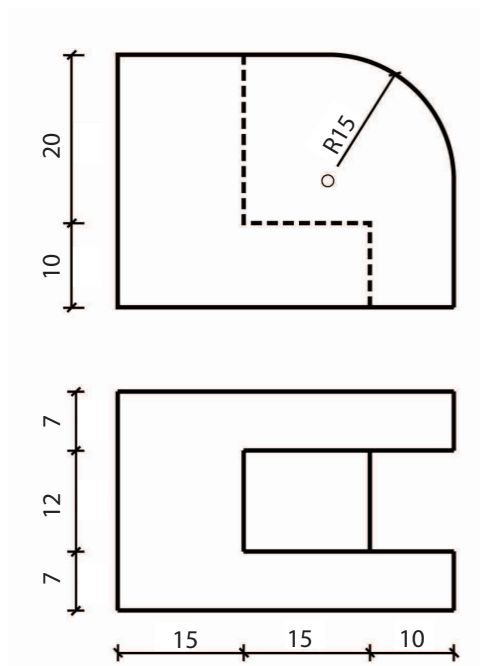

11. grupa zadatka

1.

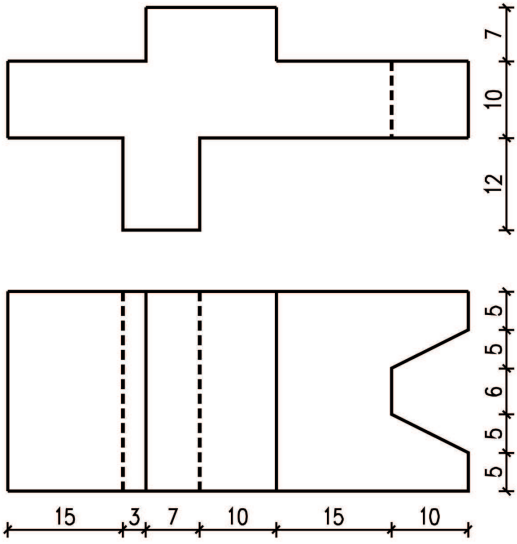

2.

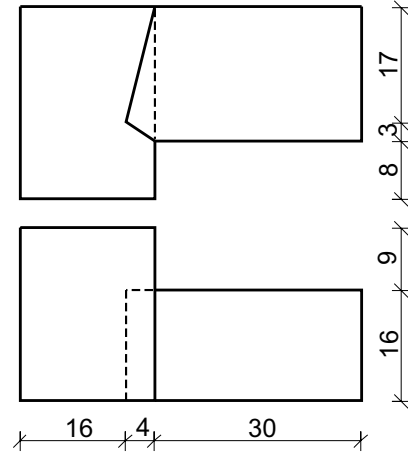

3.

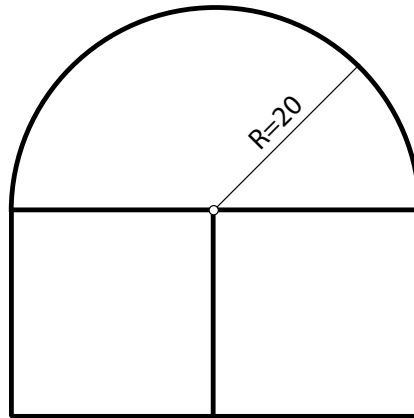
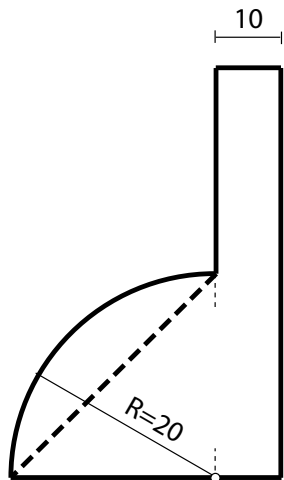

12. grupa zadatka

1.

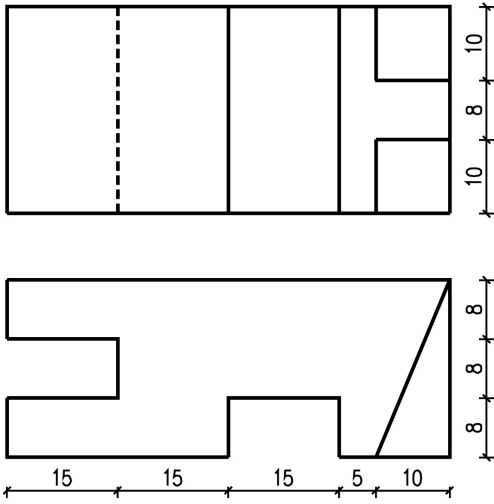

2.

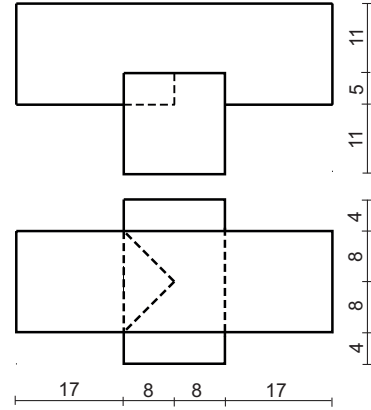

3.

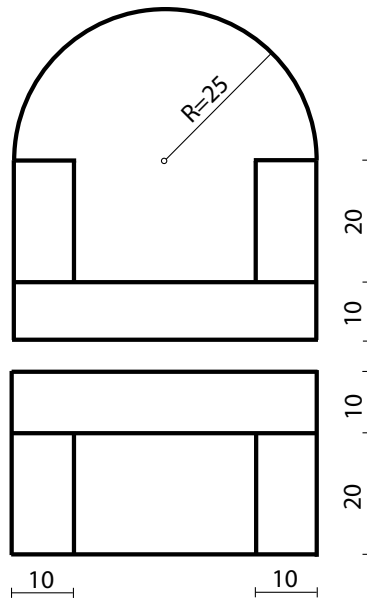

13. grupa zadatka

1.

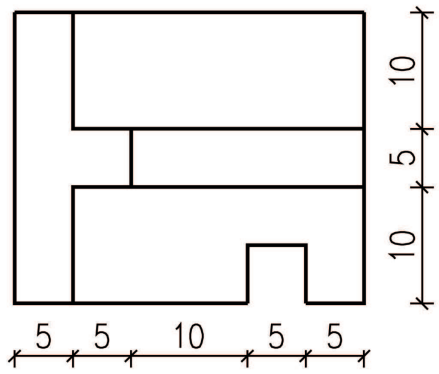
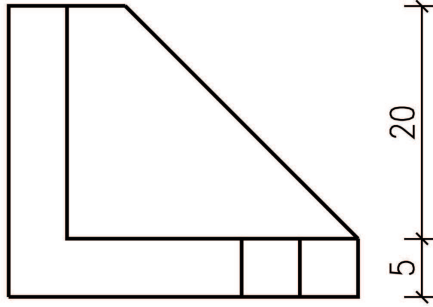

2.

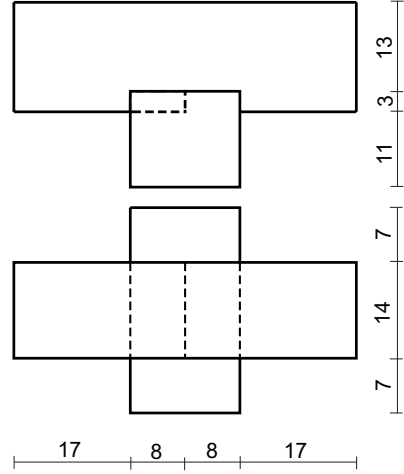

3.

