

## Dodatni zadaci za 2.program

- U programu *Rhinoceros* konstruirajte aksonometrijske slike zadanih objekata.

1.

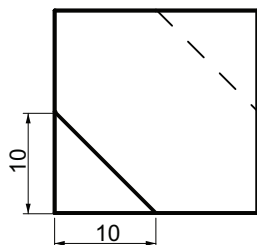
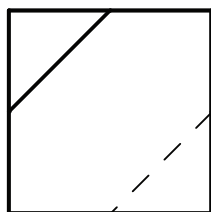
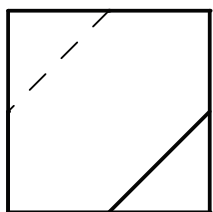

2.

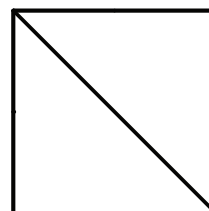
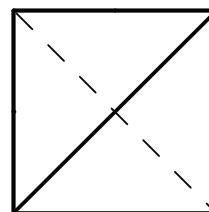
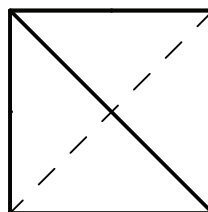

3.

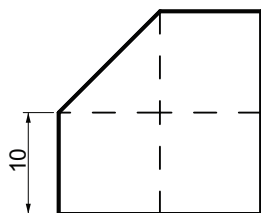
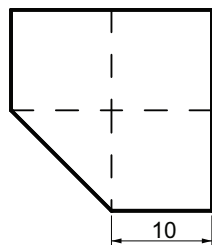
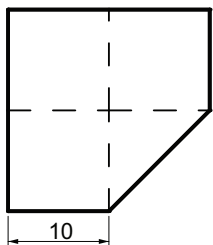

4.

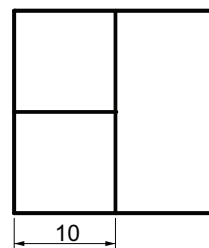
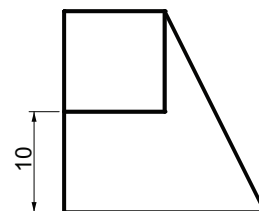
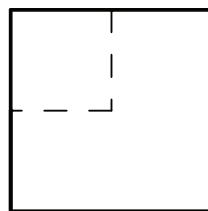

5.

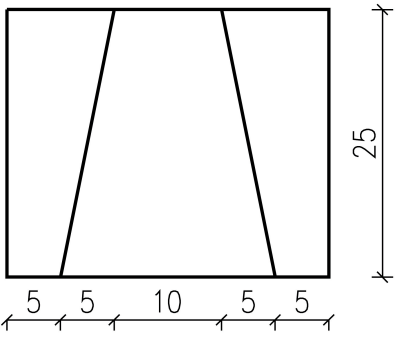
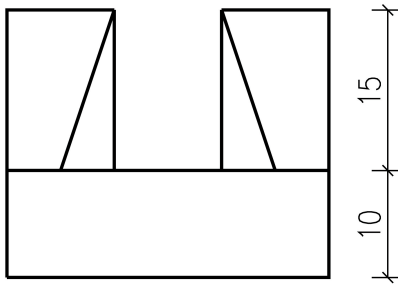

6.

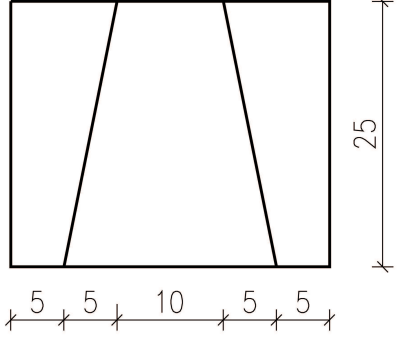
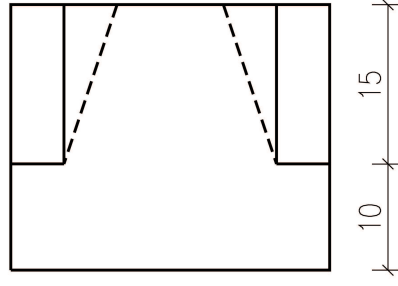

7.

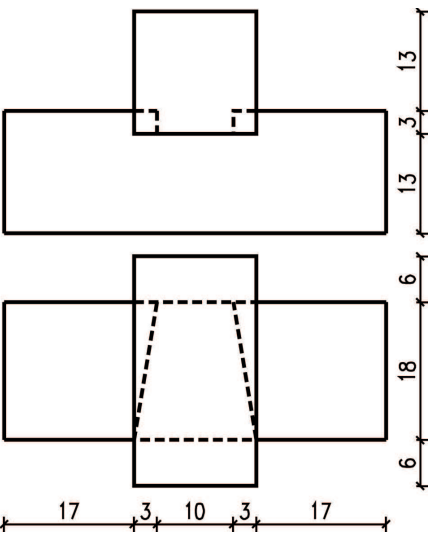

8.

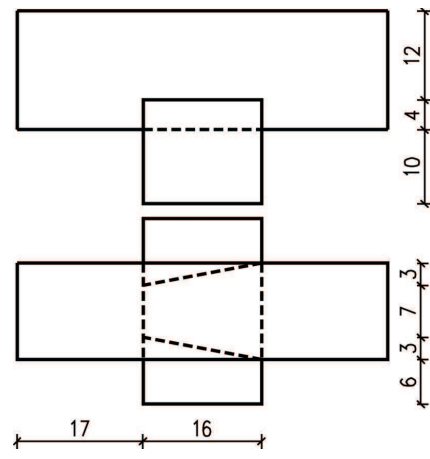

9.

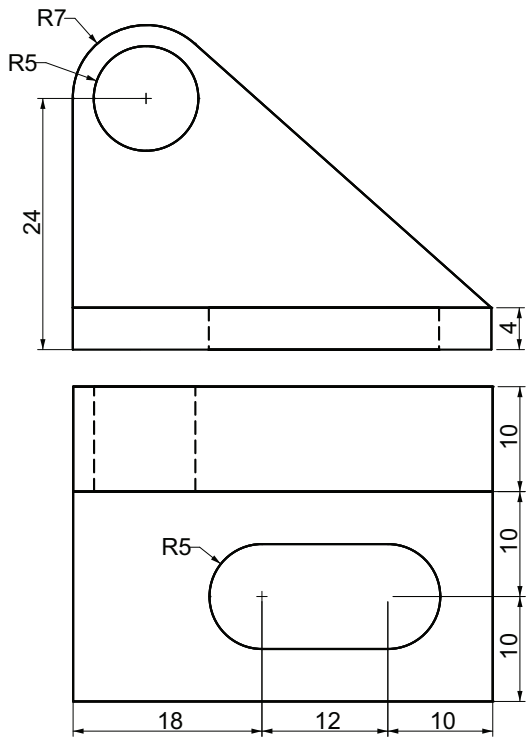

10.

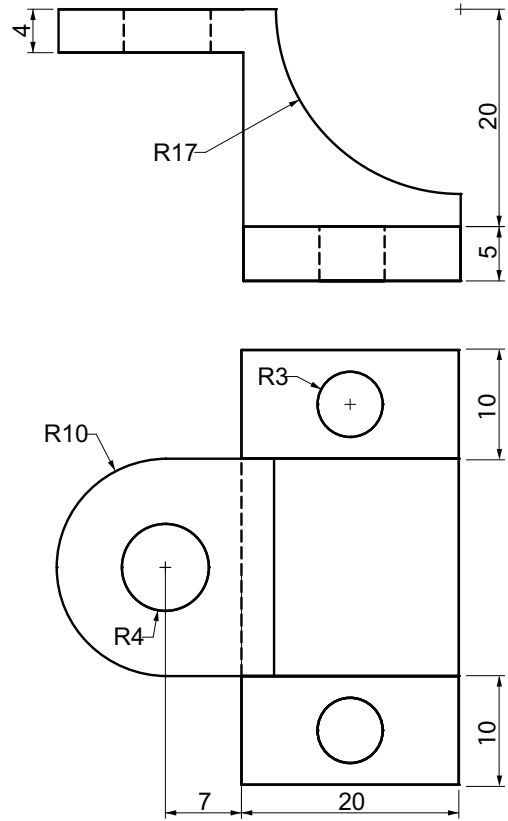

11.

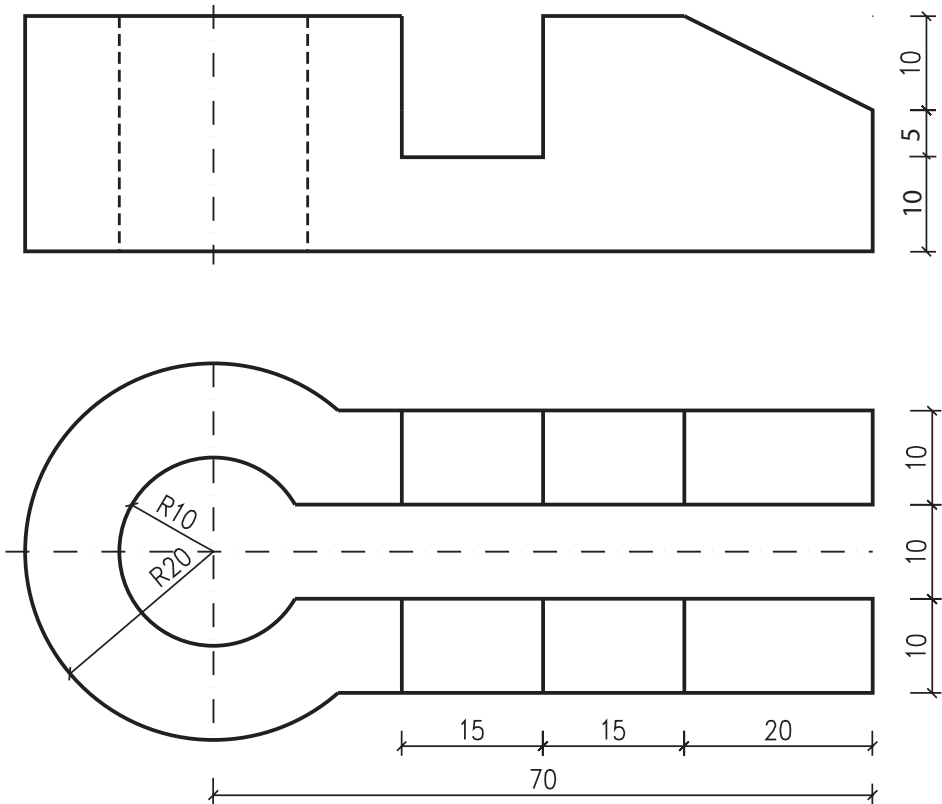

12.

